

PLAN VIEW

MANUFACTURER NOTES

SPECIFICATIONS

USER CAPACITY:	2
PRODUCT DIMENSIONS (in):	11 x 11
PRODUCT DIMENSIONS (cm):	29 x 29
WEIGHT (lb):	109
WEIGHT (kg):	49
ASTM PAD DIMENSIONS (ft):	19 x 19
ASTM PAD DIMENSIONS (m):	5.6 x 5.6

NOTES:

1. INSTALLATION TO BE COMPLETED IN ACCORDANCE WITH MANUFACTURERS' SPECIFICATIONS
2. DO NOT SCALE DRAWING
3. THIS DRAWING IS INTENDED FOR USE BY ARCHITECTS, ENGINEERS, CONTRACTORS, CONSULTANTS AND DESIGN PROFESSIONALS FOR PLANNING PURPOSES ONLY. THIS DRAWING MAY NOT BE USED FOR CONSTRUCTION.
4. ALL INFORMATION CONTAINED HEREIN WAS CURRENT AT THE TIME OF DEVELOPMENT BUT MUST BE REVIEWED AND APPROVED BY OUTDOOR-FIT TO BE CONSIDERED ACCURATE.

PROPRIETARY AND CONFIDENTIAL
 THE INFORMATION CONTAINED IN THIS DRAWING IS THE SOLE PROPERTY OF OUTDOOR-FIT. ANY REPRODUCTION IN PART OR AS A WHOLE WITHOUT THE WRITTEN PERMISSION OF OUTDOOR-FIT IS PROHIBITED.

OUTDOOR-FIT EXERCISE SYSTEMS

OUTDOOR-FIT
 95 SIMMONDS DR.
 DARTMOUTH NS
 B3B1N7
 TOLL FREE: 1-877-760-6337
 EMAIL: INFO@OUTDOOR-FIT.COM
 WEBSITE: OUTDOOR-FIT.COM

CALI-RIG 08

SKU #: OF-900-08
 SCALE: 1:25
 PAPER SIZE: 11" X 17"
 DATE: 17-JUL-25

MANUFACTURER NOTES

SPECIFICATIONS

USER CAPACITY:	2
PRODUCT DIMENSIONS (in):	11 x 11
PRODUCT DIMENSIONS (cm):	29 x 29
WEIGHT (lb):	109
WEIGHT (kg):	49
ASTM PAD DIMENSIONS (ft):	19 x 19
ASTM PAD DIMENSIONS (m):	5.6 x 5.6

NOTES:

1. INSTALLATION TO BE COMPLETED IN ACCORDANCE WITH MANUFACTURERS' SPECIFICATIONS
2. DO NOT SCALE DRAWING
3. THIS DRAWING IS INTENDED FOR USE BY ARCHITECTS, ENGINEERS, CONTRACTORS, CONSULTANTS AND DESIGN PROFESSIONALS FOR PLANNING PURPOSES ONLY. THIS DRAWING MAY NOT BE USED FOR CONSTRUCTION.
4. ALL INFORMATION CONTAINED HEREIN WAS CURRENT AT THE TIME OF DEVELOPMENT BUT MUST BE REVIEWED AND APPROVED BY OUTDOOR-FIT TO BE CONSIDERED ACCURATE.

PROPRIETARY AND CONFIDENTIAL
THE INFORMATION CONTAINED IN THIS DRAWING IS THE SOLE PROPERTY OF OUTDOOR-FIT. ANY REPRODUCTION IN PART OR AS A WHOLE WITHOUT THE WRITTEN PERMISSION OF OUTDOOR-FIT IS PROHIBITED.

OUTDOOR-FIT EXERCISE SYSTEMS

OUTDOOR-FIT
95 SIMMONDS DR.
DARTMOUTH NS
B3B1N7
TOLL FREE: 1-877-760-6337
EMAIL: INFO@OUTDOOR-FIT.COM
WEBSITE: OUTDOOR-FIT.COM

CALI-RIG 08

SKU #: OF-900-08

SCALE: 1:25

PAPER SIZE: 11" X 17"

DATE: 17-JUL-25

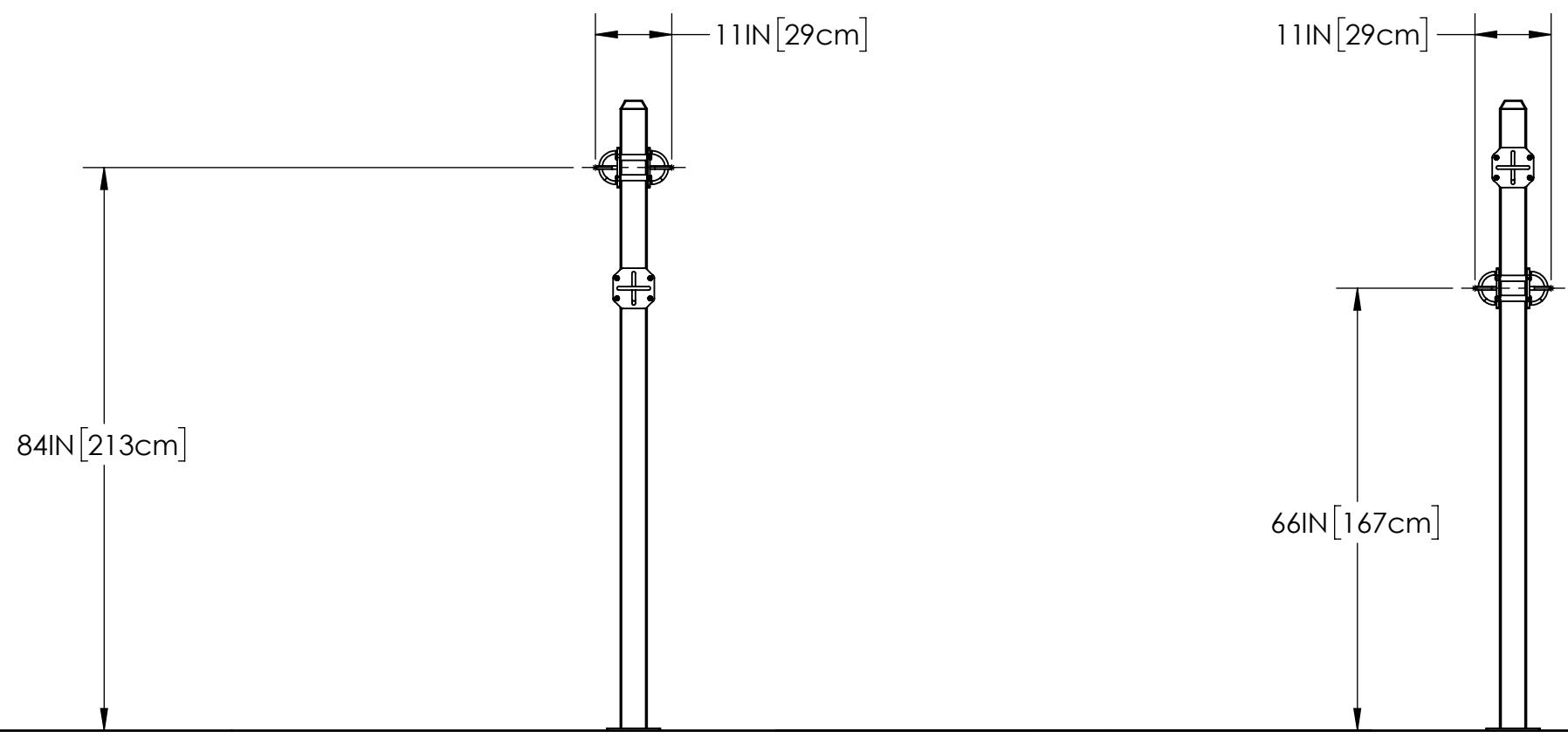

ELEVATION VIEW